

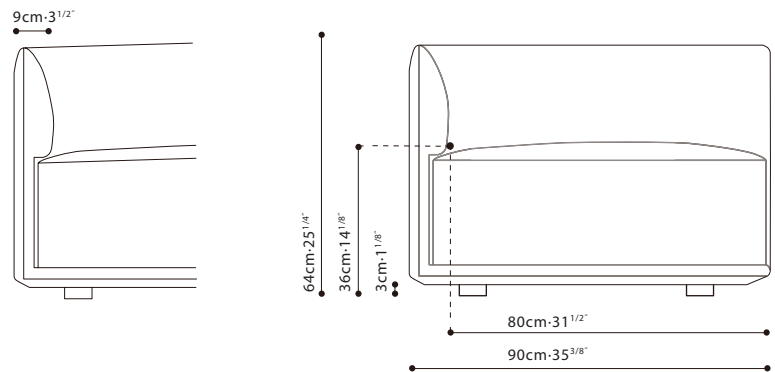

ELAN-35 / FRAME: Seat, backrest, and armrest constructed on a steel frame. The seat frame is paired with cross-woven elastic webbing. The frame is covered with polyurethane foam and fabric lining. Optional storage unit, unique to the Elan collection, is produced with wood and FU Eco Leather. **SEAT:** Seat cushions consists of solid birch bases, equipped with sinuous springs and high-resilient polyurethane foam topped with polyester fiber. **CUSHIONS:** Back cushions consists of channeled feather down and polyester fiber padding with high-resilient polyurethane foam center insert. Throw cushion C81F0204 is filled with feather down and polyester fiber, while C81F0205 is filled with feather down only. All cushions have hidden zipper closing. **LEGS:** Inset black plastic (ABS) legs giving the sofa a floating visual effect. **UPHOLSTERY:** all Fabric (removable), all Leather (non-removable), or Fabric + Leather combination.



FABRIC VERSION

C01F0201

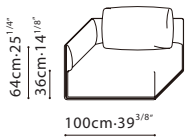

C01F0202

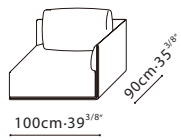

C01F0203

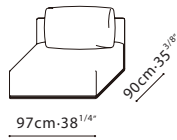

C01F0204

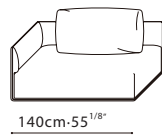

C01F0205

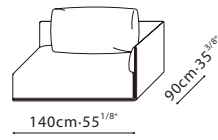

C01F0219

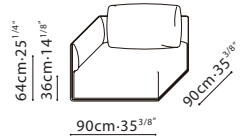

C01F0206

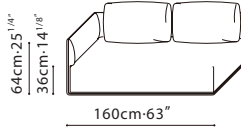

C01F0207

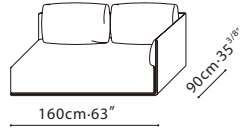

C01F0208

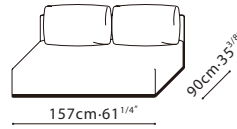

C01F0209 + C07F0216

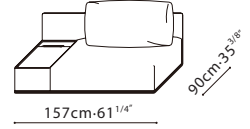
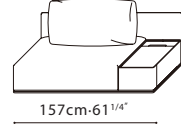
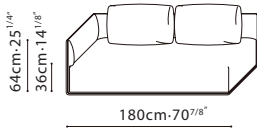
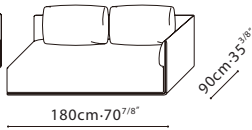

Table component can be used on either sides
*Drawer Unit comes in Grey Oak with FU-02 Black or FU-03 Taupe

C01F0210



C01F0211



C01F0212 + C07F0216

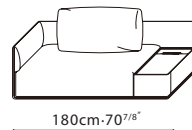

C01F0213 + C07F0216

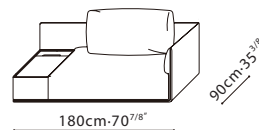

C07F0216

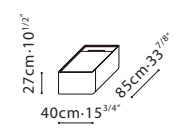

*Drawer Unit comes in Grey Oak with FU-02 Black or FU-03 Taupe

C01F0214

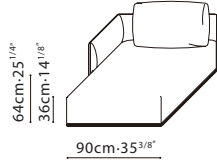

C01F0215

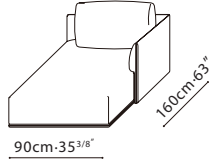

C01F0217

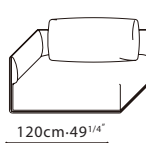

C01F0218

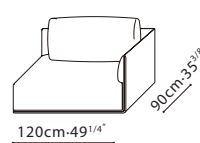

C81F0204

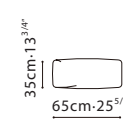

C81F0204

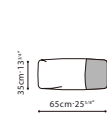

C81F0205



*The shadow part is leather, the rest is fabric

LEATHER VERSION

C01F0201

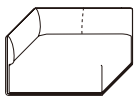

C01F0202

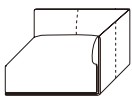

C01F0203

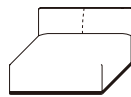

C01F0204

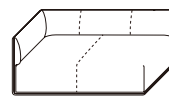

C01F0205

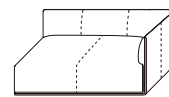

C01F0206

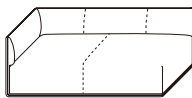

C01F0207

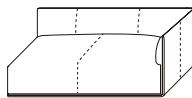

C01F0208

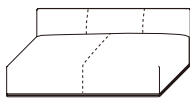

C01F0209 + C07F0216

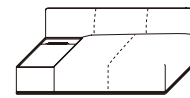
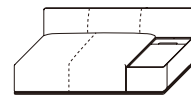

C01F0210

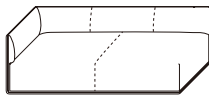

C01F0211

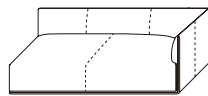

C01F0212 + C07F0216

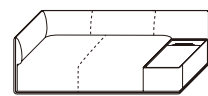

C01F0213 + C07F0216

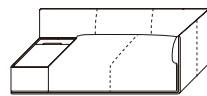

C07F0216



C01F0214

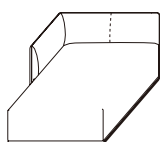

C01F0215

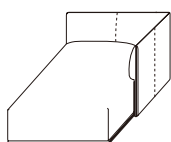

C01F0217

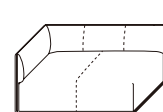

C01F0218

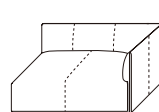

C81F0204



C81F0204



C81F0205



(dotted lines illustrate positioning of stitched seams on leather versions of this sofa)

SAMPLE CONFIGURATION

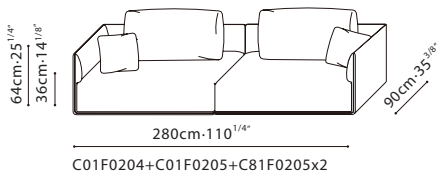

C01F0204+C01F0205+C81F0205x2

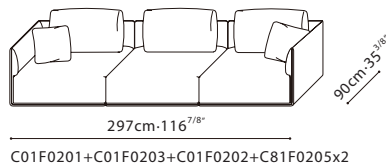

C01F0201+C01F0203+C01F0202+C81F0205x2

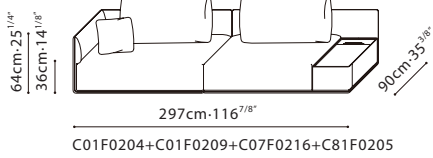

C01F0204+C01F0209+C07F0216+C81F0205

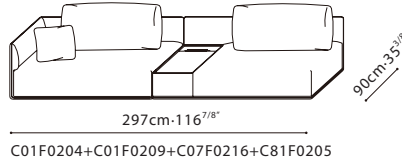

C01F0204+C01F0209+C07F0216+C81F0205

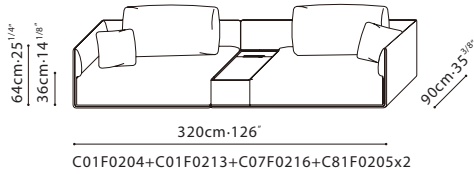

C01F0204+C01F0213+C07F0216+C81F0205x2

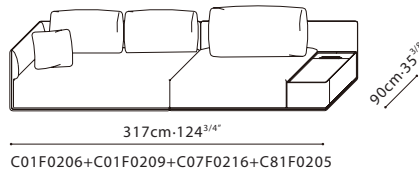

C01F0206+C01F0209+C07F0216+C81F0205

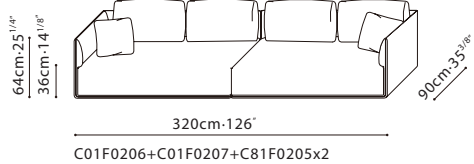

C01F0206+C01F0207+C81F0205x2

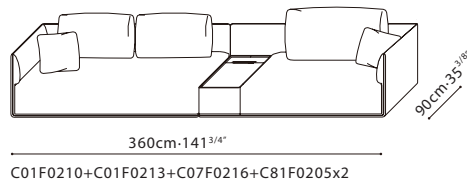

C01F0210+C01F0213+C07F0216+C81F0205x2

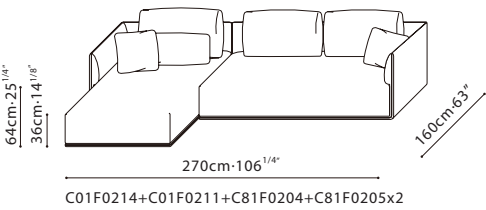

C01F0214+C01F0211+C81F0204+C81F0205x2

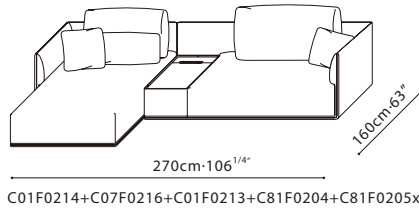

C01F0214+C07F0216+C01F0213+C81F0204+C81F0205x2

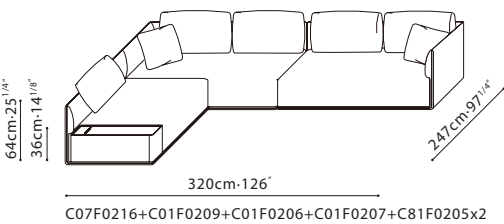

C07F0216+C01F0209+C01F0206+C01F0207+C81F0205x2

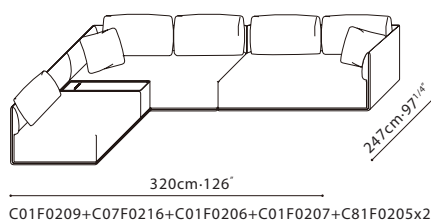

C01F0209+C07F0216+C01F0206+C01F0207+C81F0205x2

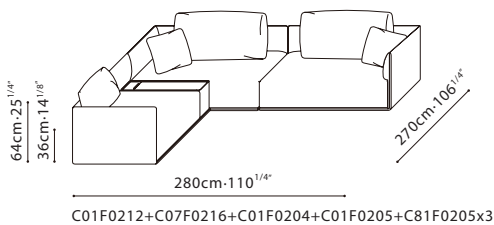

C01F0212+C07F0216+C01F0204+C01F0205+C81F0205x3